

**ROHM Packages**

**Part No. Explanation** ..... P.114  
**Package Ordering Units** ..... P.115  
**QFP Packages** ..... P.116  
**VMMP Package** ..... P.117  
**SON Packages** ..... P.118  
**QFN Packages** ..... P.119  
**SOP Packages** ..... P.120

**HSOP Packages** ..... P.122  
**Small Packages** ..... P.124  
**Non-Lead Packages** ..... P.124  
**Power Packages** ..... P.125  
**BGA Packages** ..... P.127  
**WL-CSP Packages** ..... P.127

Please refer packages from page, 128 for LAPIS Semiconductor products.

**Part No. Explanation**

- When ordering, specify the part number.
- Check each code against the tables shown below.
- Fill in from the left, leaving any extra boxes empty on the right.



Part No.

Custom Specification code

Packaging and forming specification

Alphabetical symbols specify custom product. Standard product has no symbols.

E2	Embossed tape and reel	Pin 1 fed last
(E1)	Embossed tape and reel	Pin 1 fed first
TR	Embossed tape and reel	Pin 1 fed first
(TL)	Embossed tape and reel	Pin 1 fed last

Ordering information

1. A packaging specification is not required for packaging other than taping. (Ex.) BA4558F or BA4558F-DX
2. A packaging specification is required for tape packaging. (Ex.) Example of E2-oriented embossed taping: BA4558F-E2 or BA4558F-DXE2

For example

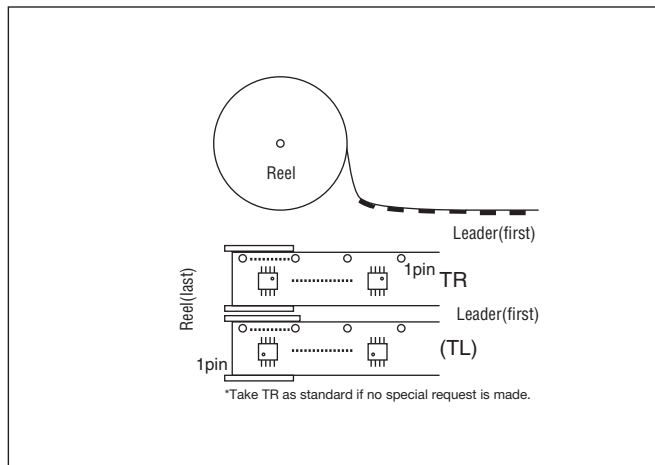
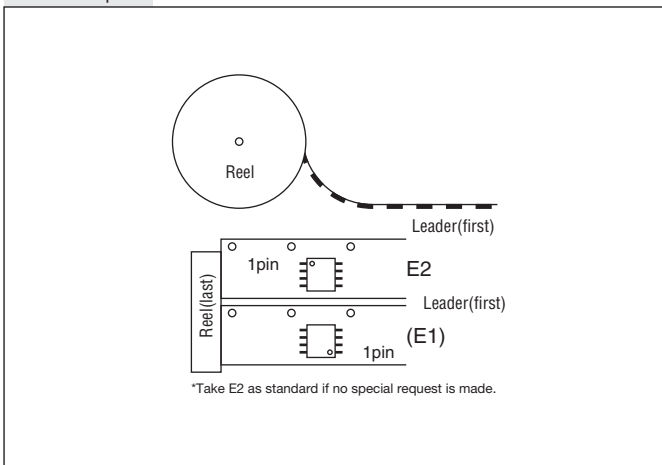

Please refer packages from page, 128 for LAPIS Semiconductor products.

## Package Ordering Units

Embossed tape packaging <Package specification name: E2 (E1)>

Package ordering unit quantity	Non-Lead Gull Wing Packages	SOP Packages	Power Packages	QFP Packages	BGA/QFN
5,000	SSON004X1216*, SSON004X1010	-	-	-	-
4,000	WSON008X2120, VSON008X2020, VSON008X2030, VSON010X3020, VSON010X3030, VMMP008Z1830*	-	-	-	-
3,000	VSOF5*, HVSOF5/6*, HSON8*, WSOF5/6*, VSON008V2030*, VSON010V3030, VQFN016V3030, WL-CSP (2.8mm and under)	TSSOP-B8, SOP4*, SSOP3/5/6*, MSOP8/10*	-	-	-
2,500	VQFN020V4040, VQFN024V4040, VQFN028V5050, VQFN032V5050, UQFN036V5050, UQFN040V5050, WL-CSP (over 2.81mm )	SOP8/14/16, SSOP-A16, TSSOP-B14J, SSOP-B8/14/16/20, SOP-J8/J14, HTSSOP-16/20/28, HTSOP-J8, TSSOP-B8J	-	-	4x4mm
2,000	VQFN040V6060, UQFN044V6060	SOP18/20/24, SSOP-A20/24/32, SSOP-B24/28/40, HTSSOP-B24/30/40, HSOP25	HRP5/7*, TO252-3/5, SOT223-4, TO263-7, TO252-J3/J5	-	6x6mm
1,500	VQFN048V7070, UQFN056V7070	SSOP-A44, HTSSOP-A44/A44R/B54, HSOP28/-M28/-M36	-	QFP32, TQFP48V, VQFP48C, HTQFP48V, UQFP64, TQFP64U	-
1,000	-	-	-	SQFP-T52, QFP44, VQFP64, VQFP80, UQFP80, TQFP64V, HTQFP64AV, HTQFP64BV	-
500	-	-	TO263-3/5	VQFP100, TQFP100V	-

1) \*Package specification: TR (TL)

2) Specification differ by package size of WL-CSP

3) WL-CSP Package Specification: E2 (standard)

### Tray packaging

Pin pitch: 0.8 mm	Pin pitch: 0.65 mm	Pin pitch: 0.5 mm	Pin pitch: 0.4 mm	Dimensions d×e (mm)	Individual package quantity	Tray quantity	Package ordering unit quantity	Tomson Case dimensions A×B×C (mm)
QFP32	-	VQFP48C	-	175×166	100	10	1,000	60×200×200
QFP44	SQFP-T52/64	VQFP64/80, TQFP48V/64V	UQFP80	216×116	50	20	1,000	70×130×510
QFP-A64, QFP80/T80	-	VQFP100, TQFP100V, HTQFP100V	TQFP128U	256×166	50	10	500	75×200×290
QFP120	-	-	-	322.6×135.9	24	10	240	75×140×338

Please refer packages from page, 128 for LAPIS Semiconductor products.

**QFP Packages**

(Unit: mm)

**QFP <Pin Pitch: 0.8mm>**

**QFP32**

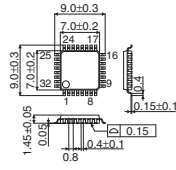

Tray: 1,000pcs  
Embossed carrier tape: 1,500pcs

**QFP44**

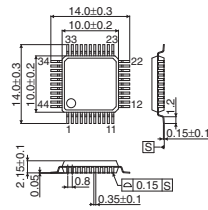

Tray: 1,000pcs  
Embossed carrier tape: 1,000pcs

**SQFP <Pin Pitch: 0.65mm>**

**SQFP-T52**

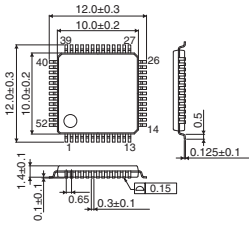

Tray: 1,000pcs  
Embossed carrier tape: 1,000pcs

**SQFP-T64**

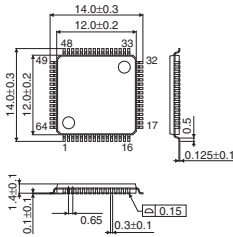

Tray: 1,000pcs

**TQFPV <Pin Pitch: 0.5mm>**

**TQFP48V**

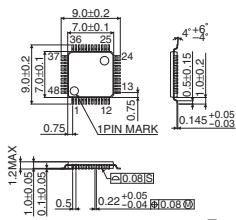

Tray: 1,000pcs  
Embossed carrier tape: 1,500pcs

**TQFP64V**

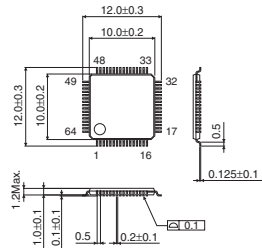

Tray: 1,000pcs  
Embossed carrier tape: 1,000pcs

**TQFP100V**

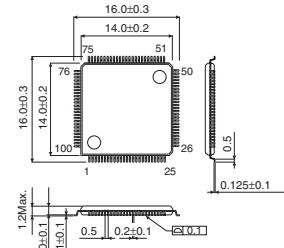

Tray: 500pcs  
Embossed carrier tape: 500pcs

IC Packages

Please refer packages from page, 128 for LAPIS Semiconductor products.

# QFP Packages

(Unit: mm)

## VQFP <Pin Pitch: 0.5mm>

### VQFP48C

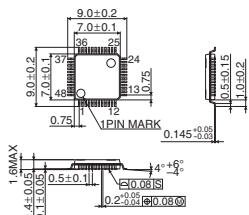

Tray: 1,000pcs  
Embossed carrier tape: 1,500pcs

### VQFP64

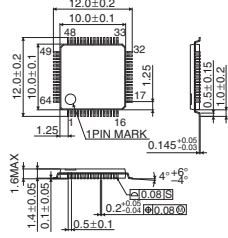

Tray: 1,000pcs  
Embossed carrier tape: 1,000pcs

### VQFP80

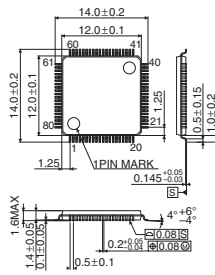

Tray: 1,000pcs  
Embossed carrier tape: 1,000pcs

### VQFP100

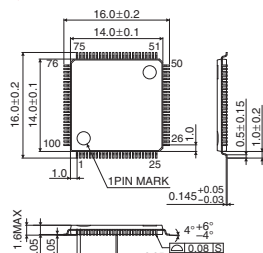

Tray: 500pcs  
Embossed carrier tape: 500pcs

## UQFP <Pin Pitch: 0.4mm>

### UQFP80

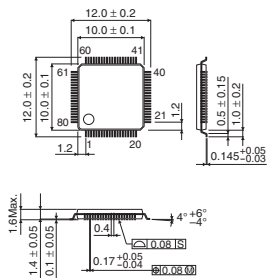

Tray: 1,000pcs  
Embossed carrier tape: 1,000pcs

## TQFPU <Pin Pitch: 0.4mm>

### TQFP128U

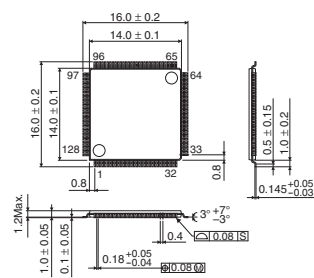

Tray: 500pcs

## HTQFPV <Pin Pitch: 0.5mm>

### HTQFP48V

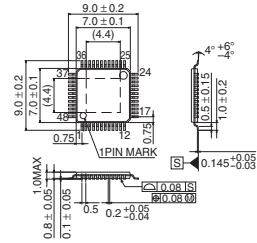

Tray: 1,000pcs  
Embossed carrier tape: 1,500pcs

### HTQFP100V

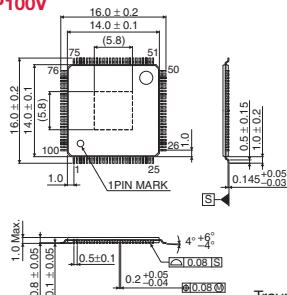

Tray: 500pcs

# VMMP Package

(Unit: mm)

## VMMP <Pin Pitch: 0.5mm>

### VMMP008Z1830

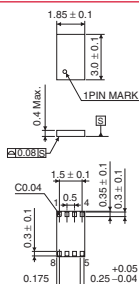

Embossed carrier tape: 4,000pcs

Please refer packages from page, 128 for LAPIS Semiconductor products.

**SON Packages**

(Unit: mm)

**SSON-X <Pin Pitch: 0.65mm>**

**VSON-V <Pin Pitch: 0.5mm>**

**SSON004X1010**

**SSON004X1216**

**VSON008V2030**

**VSON010V3030**

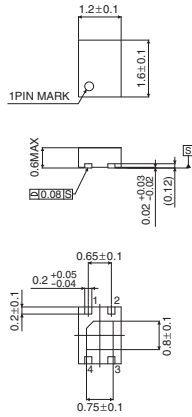
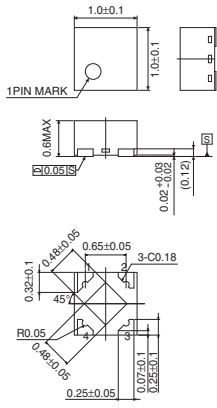

Embossed carrier tape: 5,000pcs

Embossed carrier tape: 5,000pcs

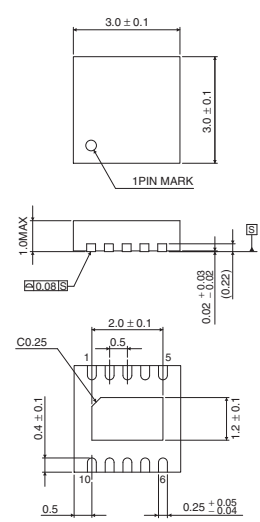
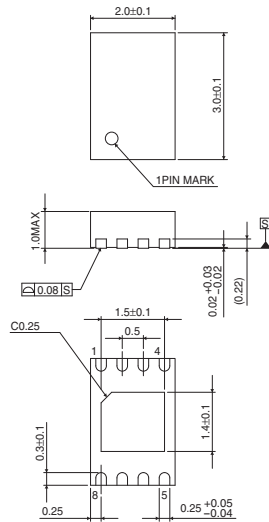

Embossed carrier tape: 3,000pcs

Embossed carrier tape: 3,000pcs

**VSON-X <Pin Pitch: 0.5mm>**

**VSON008X2020**

**VSON008X2030**

**VSON010X3020**

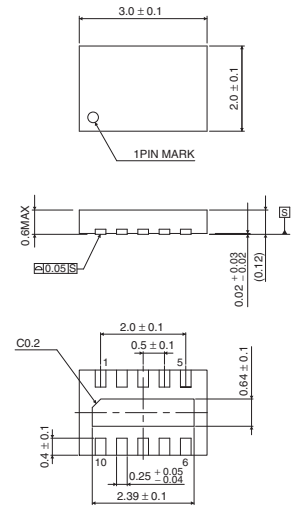
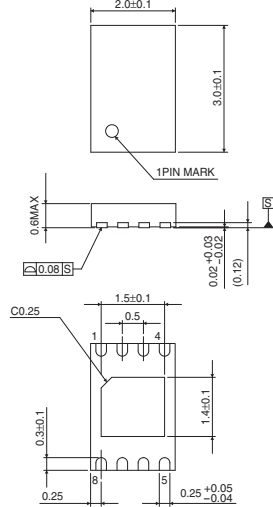
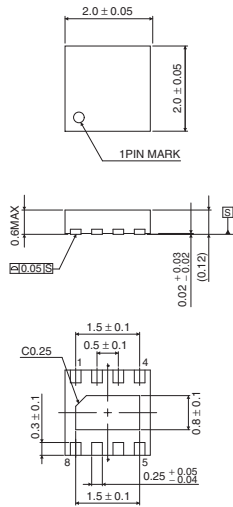

Embossed carrier tape: 4,000pcs

Embossed carrier tape: 4,000pcs

Embossed carrier tape: 4,000pcs

**VSON010X3030**

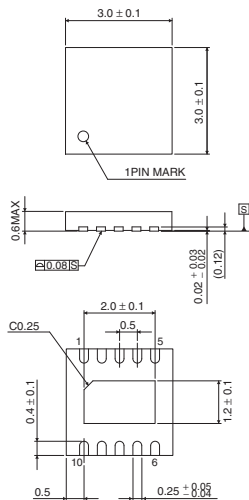

Embossed carrier tape: 4,000pcs

IC Packages

Please refer packages from page, 128 for LAPIS Semiconductor products.

# QFN Packages

(Unit: mm)

## QFN028 <Pin Pitch: 0.4mm>

### QFN028 (Powervation series)

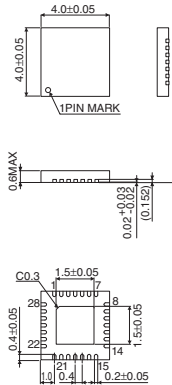

Tape: 250, 500, 1,000, 5,000pcs

## QFN032 <Pin Pitch: 0.5mm>

### QFN032 (Powervation series)

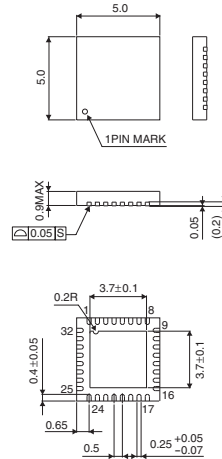

Tape: 250, 500, 1,000, 5,000pcs

## VQFN-V <Pin Pitch: 0.5mm>

### VQFN016V3030

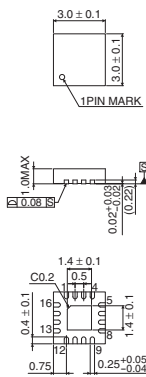

Embossed carrier tape: 3,000pcs

### VQFN020V4040

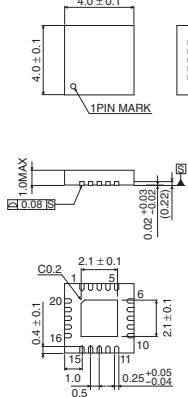

Embossed carrier tape: 2,500pcs

### VQFN024V4040

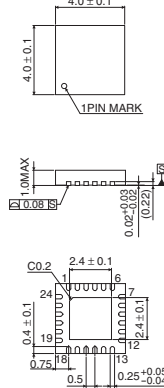

Embossed carrier tape: 2,500pcs

### VQFN028V5050

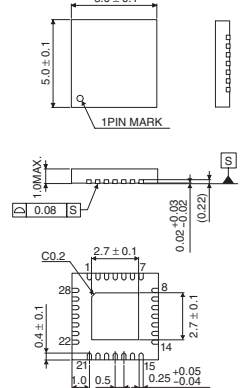

Embossed carrier tape: 2,500pcs

### VQFN032V5050

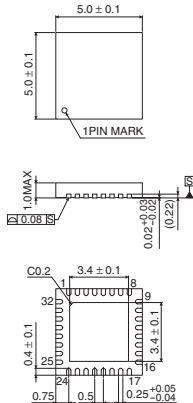

Embossed carrier tape: 2,500pcs

### VQFN040V6060

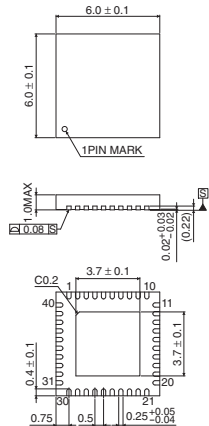

Embossed carrier tape: 2,000pcs

### VQFN048V7070

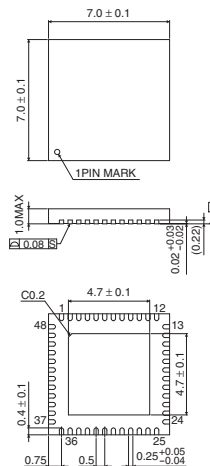

Embossed carrier tape: 1,500pcs

Please refer packages from page, 128 for LAPIS Semiconductor products.

**QFN Packages**

(Unit: mm)

**UQFN-V <Pin Pitch: 0.4mm>**

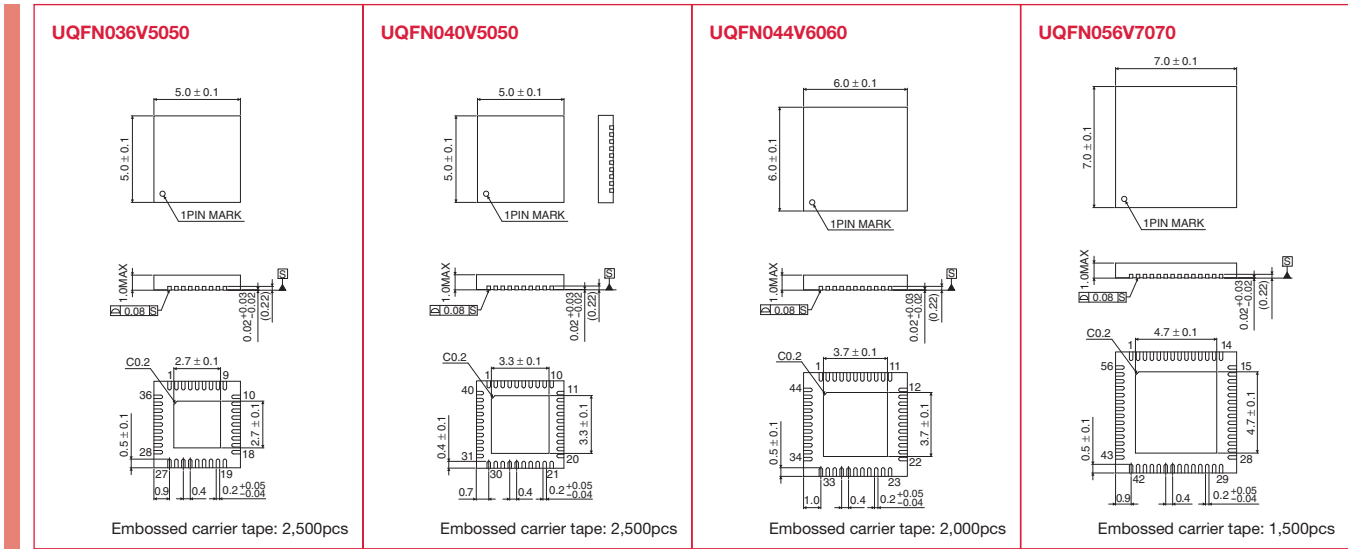

**SOP Packages**

(Unit: mm)

**SOP <Pin Pitch: 1.27mm>**

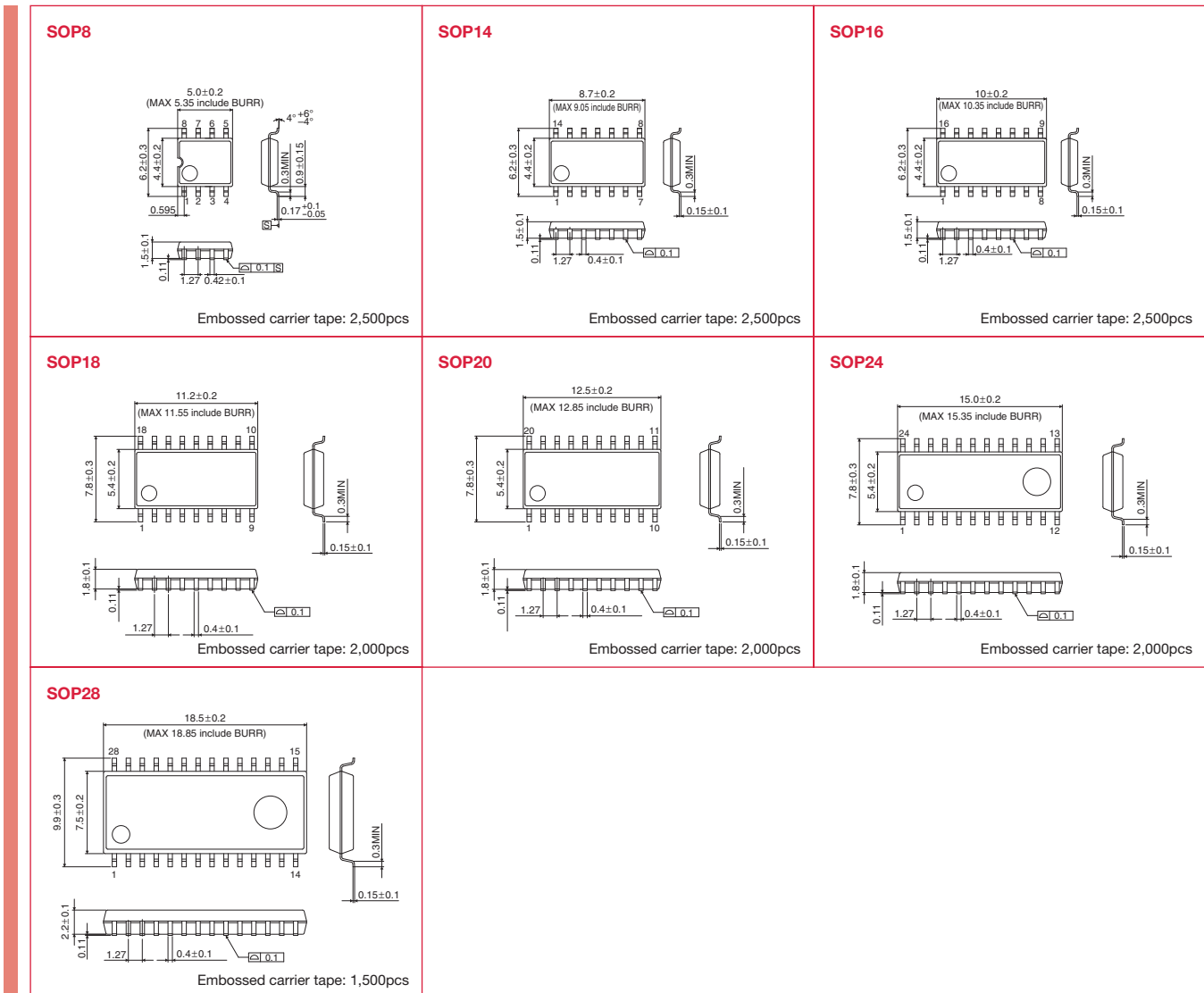

IC Packages

Please refer packages from page, 128 for LAPIS Semiconductor products.

# SOP Packages

(Unit: mm)

## SSOP-A <Pin Pitch: 0.8mm>

**SSOP-A16**

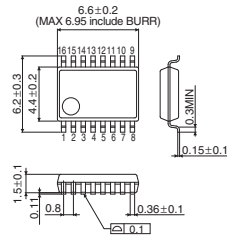

Embossed carrier tape: 2,500pcs

**SSOP-A20**

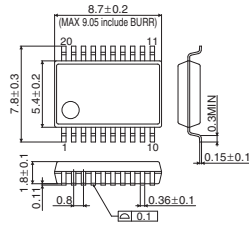

Embossed carrier tape: 2,000pcs

**SSOP-A24**

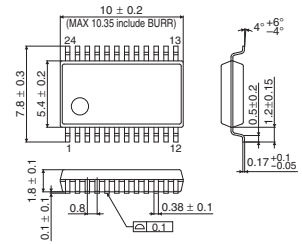

Embossed carrier tape: 2,000pcs

**SSOP-A32**

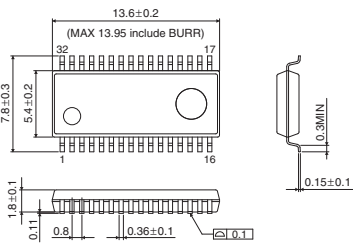

Embossed carrier tape: 2,000pcs

**SSOP-A44**

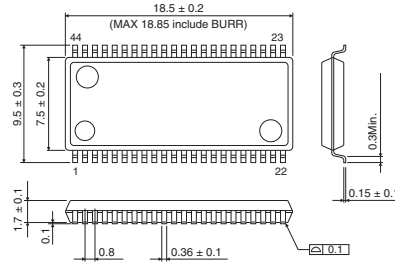

Embossed carrier tape: 1,500pcs

## SSOP-B <Pin Pitch: 0.65mm>

**SSOP-B8**

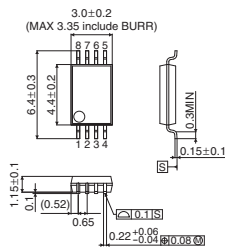

Embossed carrier tape: 2,500pcs

**SSOP-B14**

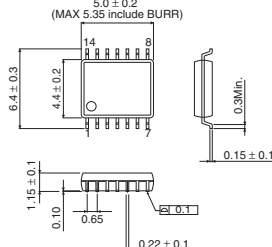

Embossed carrier tape: 2,500pcs

**SSOP-B16**

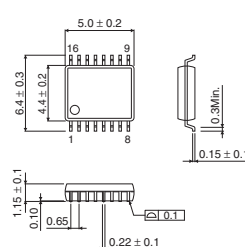

Embossed carrier tape: 2,500pcs

**SSOP-B20**

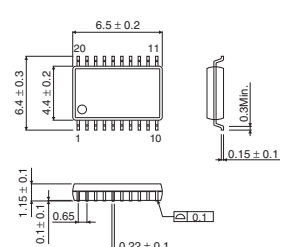

Embossed carrier tape: 2,500pcs

**SSOP-B24**

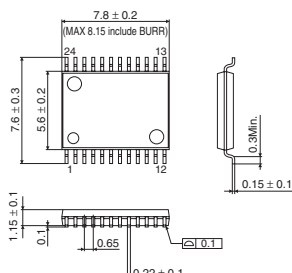

Embossed carrier tape: 2,000pcs

**SSOP-B28**

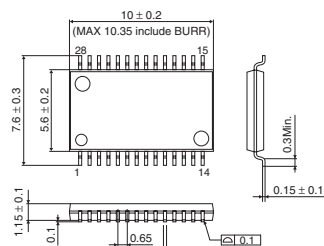

Embossed carrier tape: 2,000pcs

**SSOP-B40**

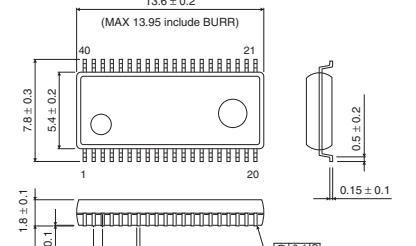

Embossed carrier tape: 2,000pcs

IC Packages



Please refer packages from page, 128 for LAPIS Semiconductor products.

**SOP Packages**

(Unit: mm)

JEDEC <Pin Pitch: 1.27mm/0.65mm>

**SOP-J8**

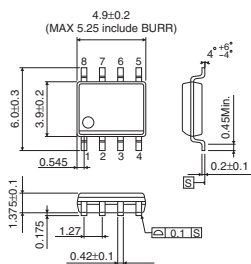

Embossed carrier tape: 2,500pcs

**SOP-J14**

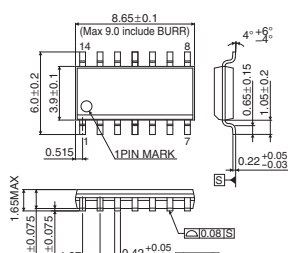

Embossed carrier tape: 2,500pcs

**TSSOP-B8**

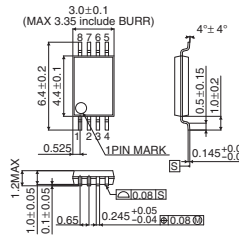

Embossed carrier tape: 3,000pcs

**TSSOP-B8J**

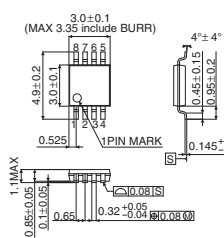

Embossed carrier tape: 2,500pcs

**TSSOP-B14J**

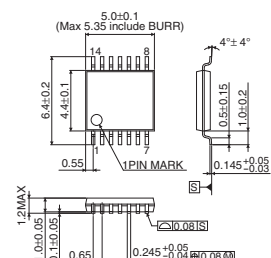

Embossed carrier tape: 2,500pcs

**HSOP Packages**

(Unit: mm)

HSOP <Pin Pitch: 0.8mm>

**HSOP25**

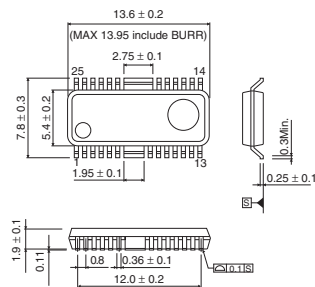

Embossed carrier tape: 2,000pcs

**HSOP-M28**

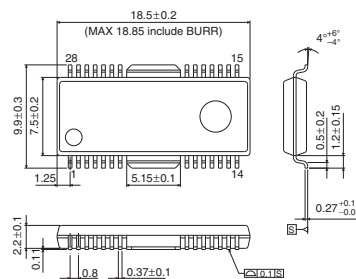

Embossed carrier tape: 1,500pcs

**HSOP-M36**

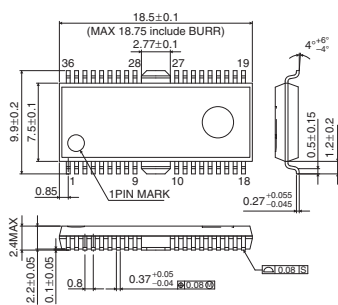

Embossed carrier tape: 1,500pcs

IC Packages

Please refer packages from page, 128 for LAPIS Semiconductor products.

## HSOP Packages

(Unit: mm)

### HTSOP-J <Pin Pitch: 1.27mm>

### HTSSOP-A <Pin Pitch: 0.8mm>

#### HTSOP-J8

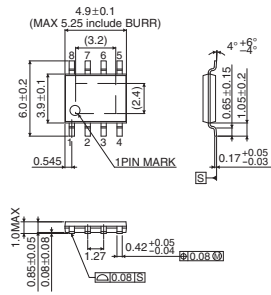

Embossed carrier tape: 2,500pcs

#### HTSSOP-A44

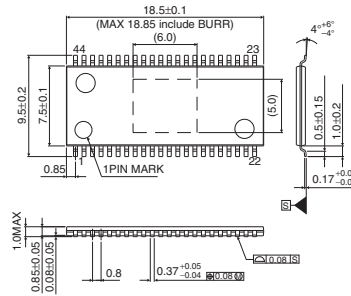

Embossed carrier tape: 1,500pcs

#### HTSSOP-A44R

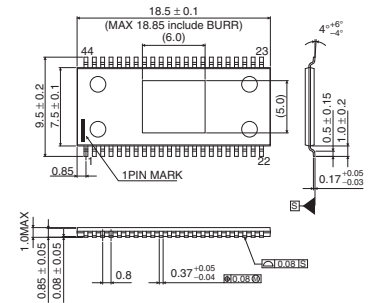

Embossed carrier tape: 1,500pcs

### HTSSOP-B <Pin Pitch: 0.65mm>

#### HTSSOP-B16

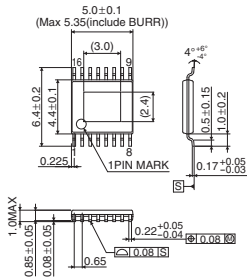

Embossed carrier tape: 2,500pcs

#### HTSSOP-B20

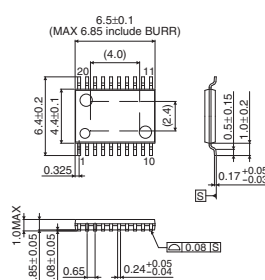

Embossed carrier tape: 2,500pcs

#### HTSSOP-B24

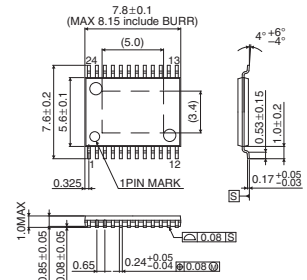

Embossed carrier tape: 2,000pcs

#### HTSSOP-B28

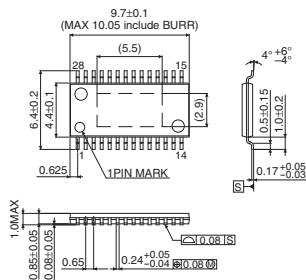

Embossed carrier tape: 2,500pcs

#### HTSSOP-B30

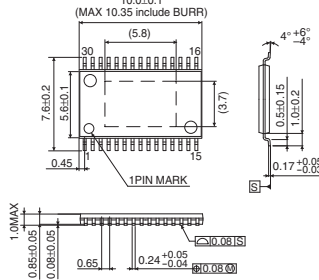

Embossed carrier tape: 2,000pcs

#### HTSSOP-B40

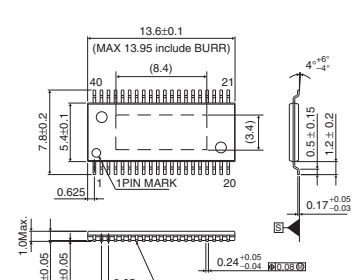

Embossed carrier tape: 2,000pcs

#### HTSSOP-B54

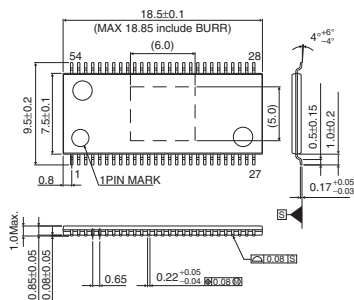

Embossed carrier tape: 1,500pcs

Please refer packages from page, 128 for LAPIS Semiconductor products.

**Small Packages**

(Unit: mm)

**SOP type**

**SOP4**

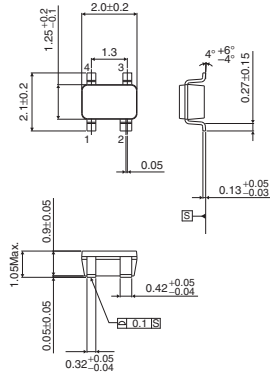

Embossed carrier tape: 3,000pcs

**SSOP3**

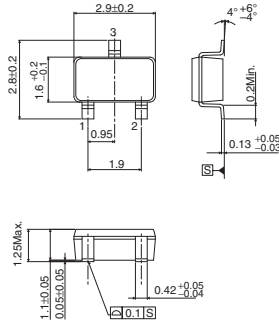

Embossed carrier tape: 3,000pcs

**SSOP5**

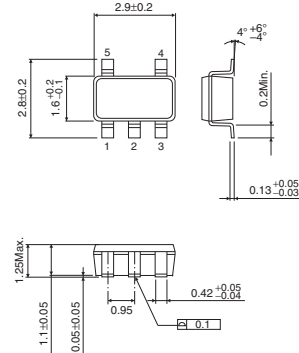

Embossed carrier tape: 3,000pcs

**SSOP6**

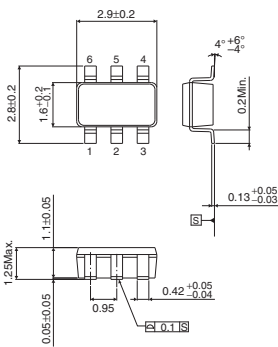

Embossed carrier tape: 3,000pcs

**MSOP8**

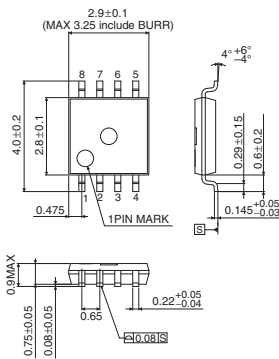

Embossed carrier tape: 3,000pcs

**MSOP10**

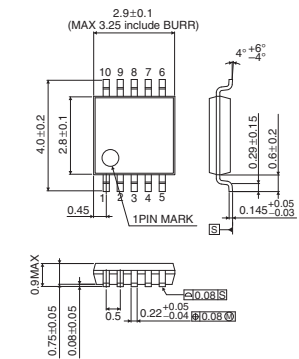

Embossed carrier tape: 3,000pcs

**Non-Lead Packages**

(Unit: mm)

**Non-Lead**

**VSO5**

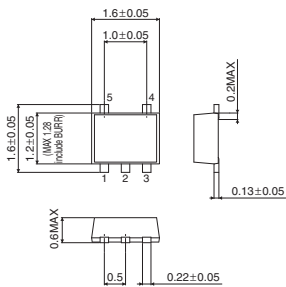

Embossed carrier tape: 3,000pcs

**HVSOF5**

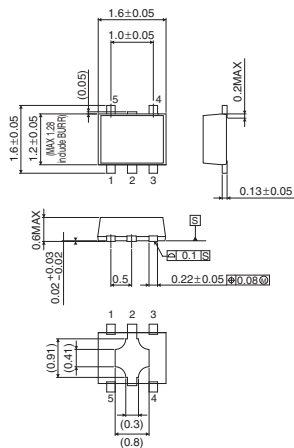

Embossed carrier tape: 3,000pcs

**HVSOF6**

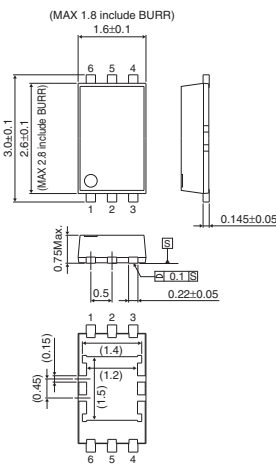

Embossed carrier tape: 3,000pcs

**HSO8**

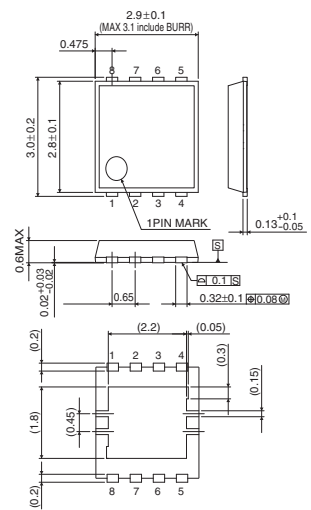

Embossed carrier tape: 3,000pcs

Please refer packages from page, 128 for LAPIS Semiconductor products.

# Non-Lead Packages

(Unit: mm)

## Optical Non-Lead

### WSOF5 (Clear type)

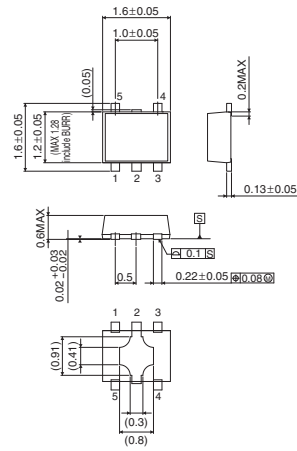

Embossed carrier tape: 3,000pcs

### WSOF6 (Clear type)

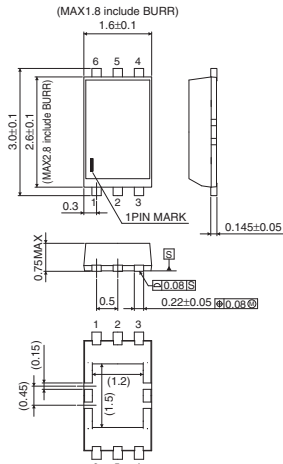

Embossed carrier tape: 3,000pcs

### WSO08X2120 (Clear type)

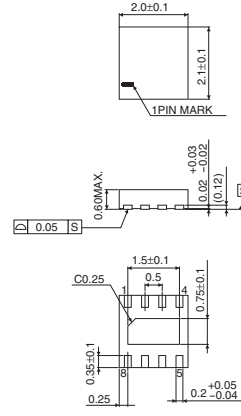

Embossed carrier tape: 4,000pcs

# Power Packages

(Unit: mm)

## POWER-3PIN

### TO220CP-3

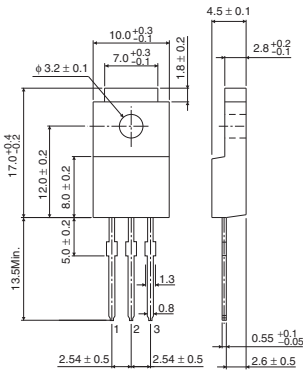

Container tube: 500pcs

### TO252-3

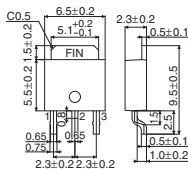

Embossed carrier tape: 2,000pcs

### TO252-J3

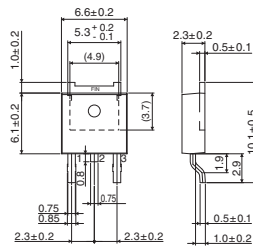

Embossed carrier tape: 2,000pcs

### TO263-3

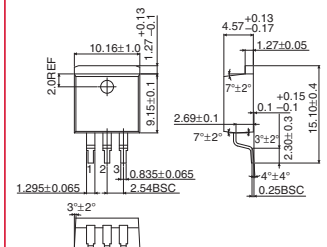

Embossed carrier tape: 500pcs

## POWER-4PIN

### SOT223-4

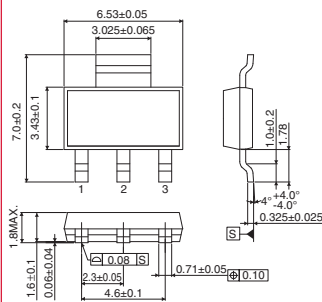

Embossed carrier tape: 2,000pcs

Please refer packages from page, 128 for LAPIS Semiconductor products.

**Power Packages**

(Unit: mm)

**POWER-5PIN**

**TO220FP-5**

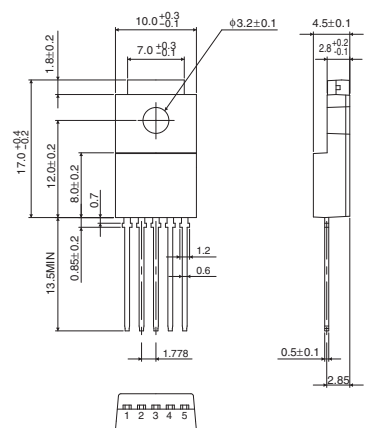

Container tube: 500pcs

**TO252-5**

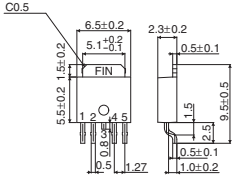

Embossed carrier tape: 2,000pcs

**HRP5**

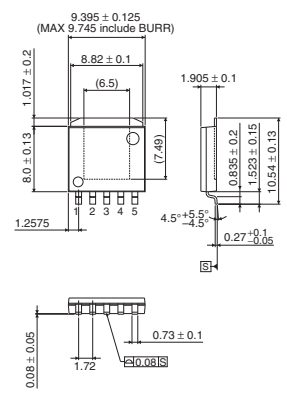

Embossed carrier tape: 2,000pcs

**TO263-5**

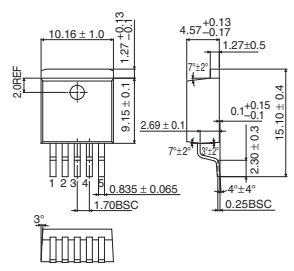

Embossed carrier tape: 500pcs

**TO252-J5**

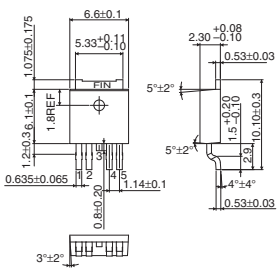

Embossed carrier tape: 2,000pcs

**POWER-7PIN**

**HRP7**

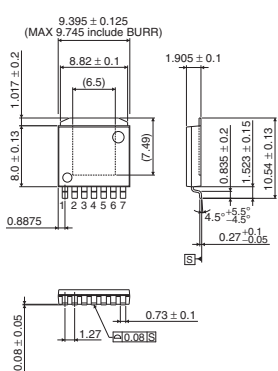

Embossed carrier tape: 2,000pcs

**TO263-7**

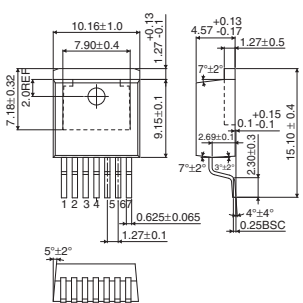

Embossed carrier tape: 2,000pcs

IC Packages

Please refer packages from page, 128 for LAPIS Semiconductor products.

## BGA Packages

(Unit: mm)

### VBGA-W <Pin Pitch: 0.5mm>

**VBGA048W040**

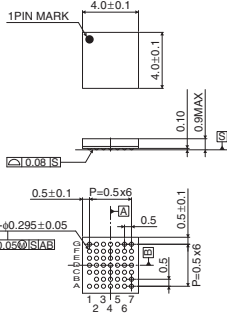

Embossed carrier tape: 2,500pcs

**VBGA099W060**

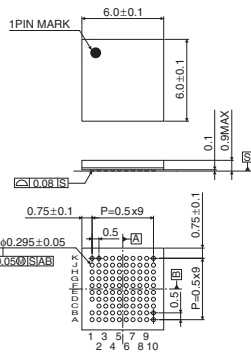

Embossed carrier tape: 2,000pcs

## WL-CSP Packages

(Unit: mm)

### VCSP <Pin Pitch: 0.5mm>

**VCSP85H**

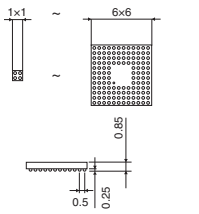

2.8mm and under: 3,000pcs  
Over 2.81mm : 2,500pcs

**VCSP50L**

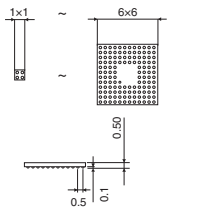

2.8mm and under: 3,000pcs  
Over 2.81mm : 2,500pcs

**VCSP35L**

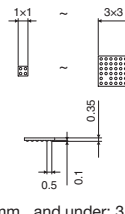

2.8mm and under: 3,000pcs  
Over 2.81mm : 2,500pcs  
Embossed carrier tape: 3,000pcs

**VCSP30L**

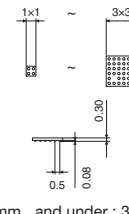

2.8mm and under: 3,000pcs  
Over 2.81mm : 2,500pcs  
Embossed carrier tape: 3,000pcs

### UCSP <Pin Pitch: 0.4mm>

**UCSP75M**

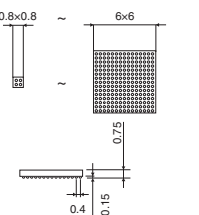

2.8mm and under: 3,000pcs  
Over 2.81mm : 2,500pcs

**UCSP50L**

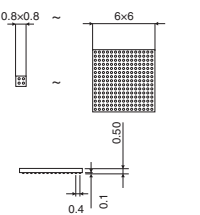

2.8mm and under: 3,000pcs  
Over 2.81mm : 2,500pcs

**UCSP35L**

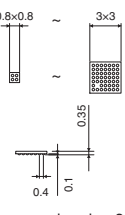

2.8mm and under: 3,000pcs  
Over 2.81mm : 2,500pcs  
Embossed carrier tape: 3,000pcs

**UCSP30L**

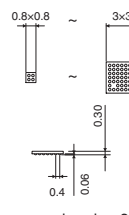

2.8mm and under: 3,000pcs  
Over 2.81mm : 2,500pcs  
Embossed carrier tape: 3,000pcs

**UCSP25L**

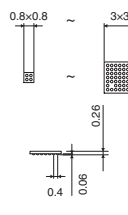

Embossed carrier tape: 3,000pcs

### XCSP <Pin Pitch: 0.35mm>

**XCSP30L**

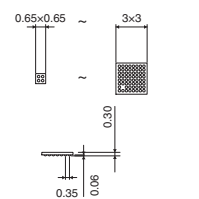

Embossed carrier tape: 3,000pcs

**ROHM**  
SEMICONDUCTOR

**ROHM Co.,Ltd.**

21 Saiin Mizosaki-cho, Ukyo-ku,  
Kyoto 615-8585 Japan  
TEL : +81-75-311-2121 FAX : +81-75-315-0172  
<https://www.rohm.com>

ROHM GROUP  
**LAPIS**  
SEMICONDUCTOR

